



ITA HOOK TYPE *fork arms*

Company Name:	
Contact Name:	
Phone Fax:	
Email:	
Date:	

Class	Distance Hooks	Height Carriage	Tick
1	h2 306mm	b 331mm	
2	h2 382mm	b 407mm	
3	h2 477mm	b 508mm	
4	h2 598mm	b 635mm	

Project Industries Serial Number:

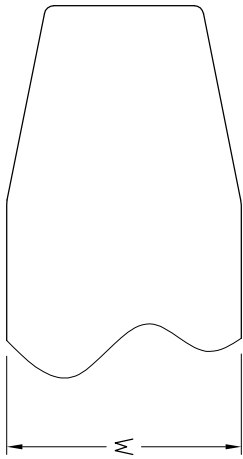

Fork Arm Details	
	Units mm
b:	
h1:	
h2:	
T:	
W:	
BH:	
BL:	

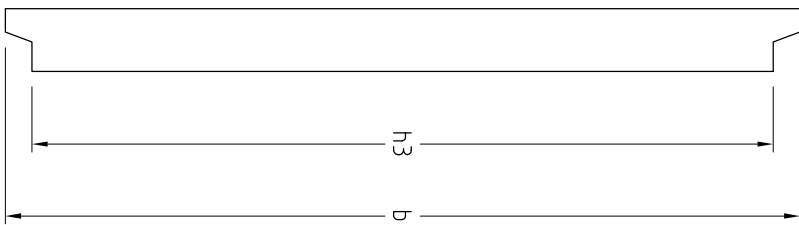
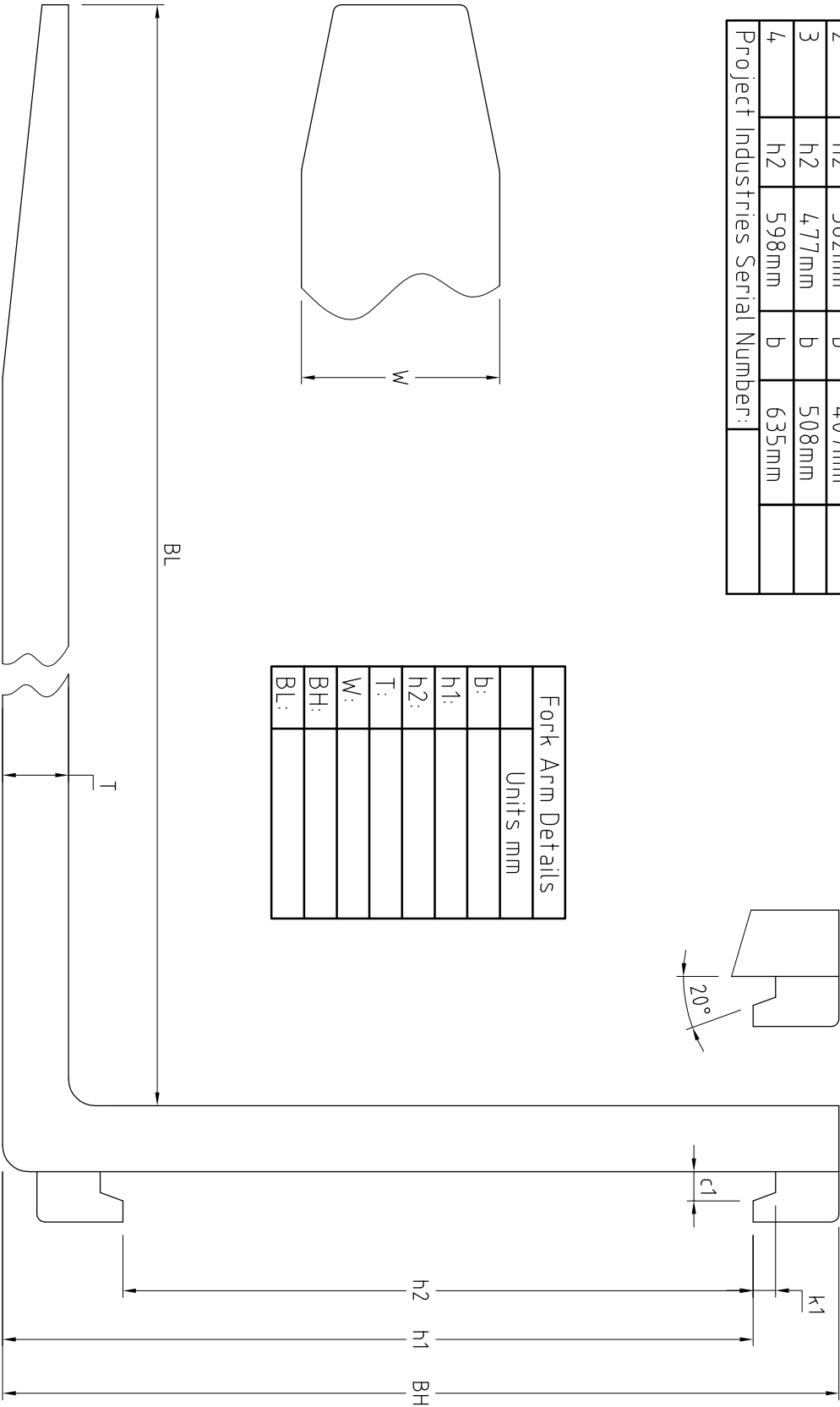
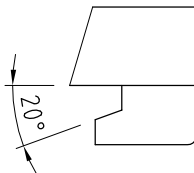



SQUARE HOOK TYPE *fork arms*

Company Name:	
Contact Name:	
Phone Fax:	
Email:	
Date:	

Project Industries Serial Number:

Fork Arm Details	
	Units mm
B:	
h1:	
h2:	
T:	
W:	
BH:	
BL:	
w1:	
w2:	
x1:	
x2:	
y1:	
y2:	
z1:	
z2:	

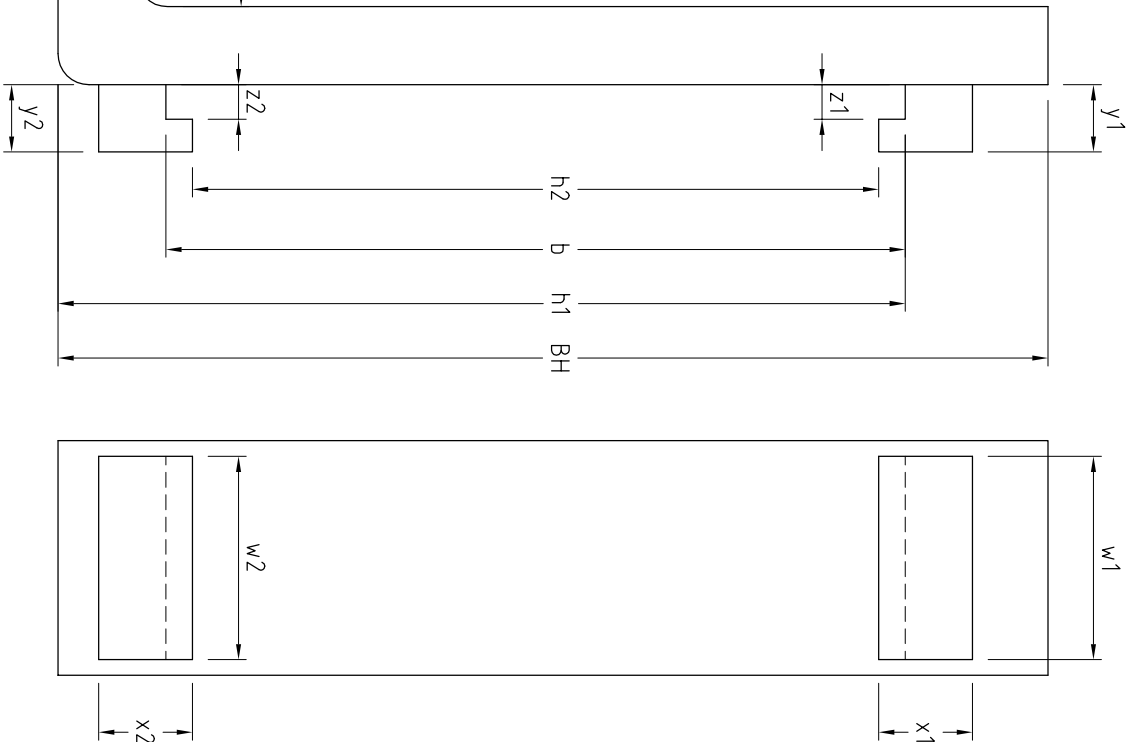
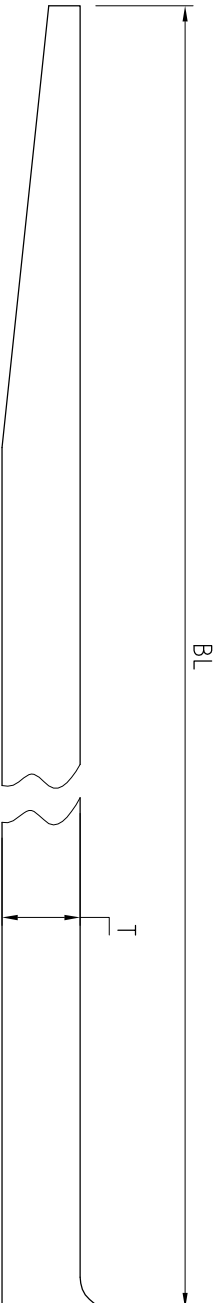
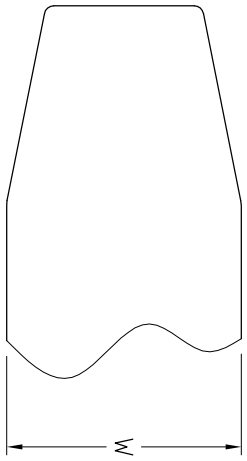



SHAFT / PIN TYPE *fork arms*

Company Name:	
Contact Name:	
Phone Fax:	
Email:	
Date:	

Project Industries Serial Number:

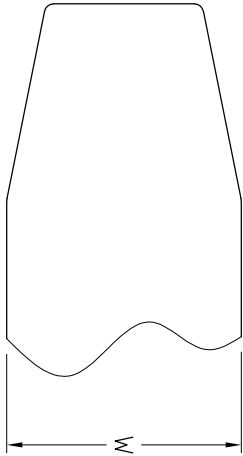

Fork Arm Details	Units mm
HB.I:	
HB.O:	
OS:	
IS:	
IL:	
BH:	
BL:	
CL:	
W:	
T:	
SHAFT / PIN ϕ	

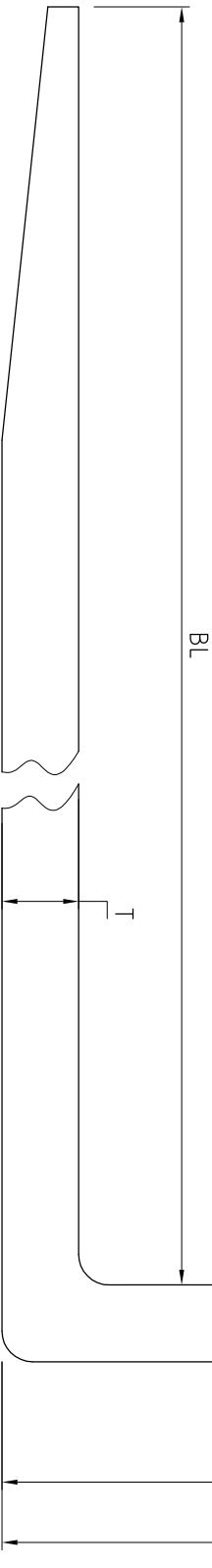
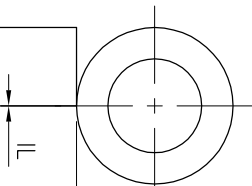
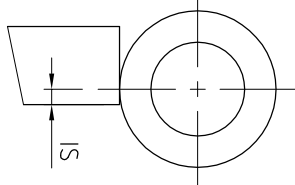
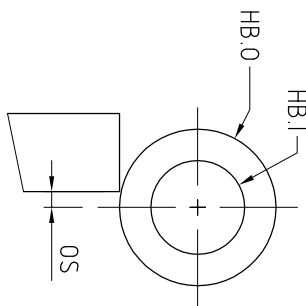

BH

CL